

LED OFFICE LIGHTING



LED PANEL LAMP (BACKLIT)



Recessed mounting
FSP30660-40



Surface mounting
FSP31660-40

| Code | Voltage | Power (W) | Lumen(lm) 3000/4000/6500K | CRI | Beam Angle | Size (mm) | Cut-out (mm) | Lifetime (hrs) | Packing QTY (pcs/CTN) |
|-------------|------------|-----------|------------------------------|-----|------------|------------|--------------|----------------|-----------------------|
| FSP30660-40 | AC220-240V | 40 | 3240/3420/3600 | ≥80 | 110° | 595x595x35 | 585x585 | 25000 | 6 |
| FSP30660-48 | AC220-240V | 48 | 3960/4140/4320 | ≥80 | 110° | 595x595x35 | 585x585 | 25000 | 6 |
| FSP31660-40 | AC220-240V | 40 | 3240/3420/3600 | ≥80 | 110° | 600x600x40 | / | 25000 | 4 |
| FSP31660-48 | AC220-240V | 48 | 3960/4140/4320 | ≥80 | 110° | 600x600x40 | / | 25000 | 4 |

Dimension (mm)

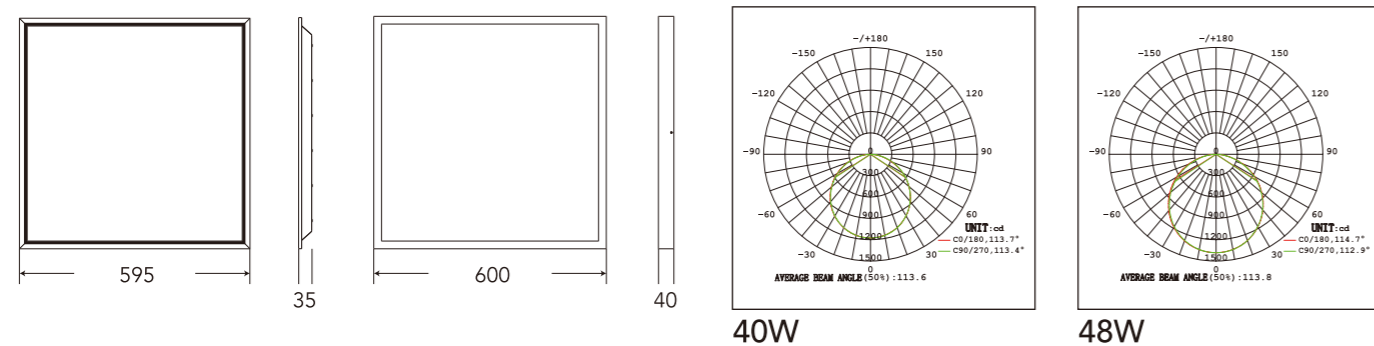

LED PANEL LAMP



| Code | Voltage | Power (W) | Lumen(lm) 3000/4000/6500K | Size (mm) | Cut-out (mm) | Packing QTY (pcs/CTN) |
|-------------------|------------|-----------|------------------------------|------------|--------------|-----------------------|
| AC180-265V | | | | | | |
| FSP26330-12 | AC180-265V | 12 | 700/800/900 | 295x295x9 | 285x285 | 10 |
| FSP26360-18 | AC180-265V | 18 | 1150/1250/1350 | 295x595x9 | 285x585 | 10 |
| FSP26660-40 | AC180-265V | 40 | 3000/3100/3200 | 595x595x9 | 585x585 | 6 |
| FSP26660-48 | AC180-265V | 48 | 3600/3700/3800 | 595x595x9 | 585x585 | 6 |
| FSP26660-60 | AC180-265V | 60 | 4600/4700/4800 | 595x595x9 | 585x585 | 6 |
| FSP26312-40 | AC180-265V | 40 | 3000/3100/3200 | 295x1195x9 | 285x1185 | 6 |
| FSP26312-48 | AC180-265V | 48 | 3600/3700/3800 | 295x1195x9 | 285x1185 | 6 |
| FSP26612-80 | AC180-265V | 80 | 6200/6300/6400 | 595x1195x9 | 585x1185 | 2 |
| AC90-265V | | | | | | |
| FSP27330-12 | AC90-265V | 12 | 700/800/900 | 295x295x9 | 285x285 | 10 |
| FSP27360-18 | AC90-265V | 18 | 1150/1250/1350 | 295x595x9 | 285x585 | 10 |
| FSP27660-40 | AC90-265V | 40 | 3000/3100/3200 | 595x595x9 | 585x585 | 6 |
| FSP27660-48 | AC90-265V | 48 | 3600/3700/3800 | 595x595x9 | 585x585 | 6 |
| FSP27660-60 | AC90-265V | 60 | 4600/4700/4800 | 595x595x9 | 585x585 | 6 |
| FSP27312-40 | AC90-265V | 40 | 3000/3100/3200 | 295x1195x9 | 285x1185 | 6 |
| FSP27312-48 | AC90-265V | 48 | 3600/3700/3800 | 295x1195x9 | 285x1185 | 6 |
| FSP27612-80 | AC90-265V | 80 | 6200/6300/6400 | 595x1195x9 | 585x1185 | 2 |

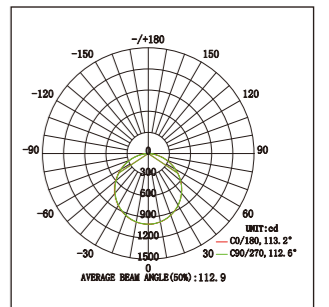

40W

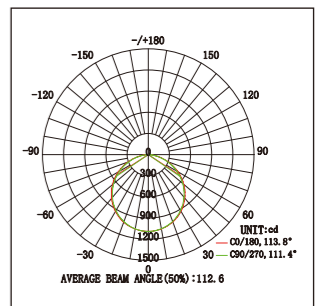

48W

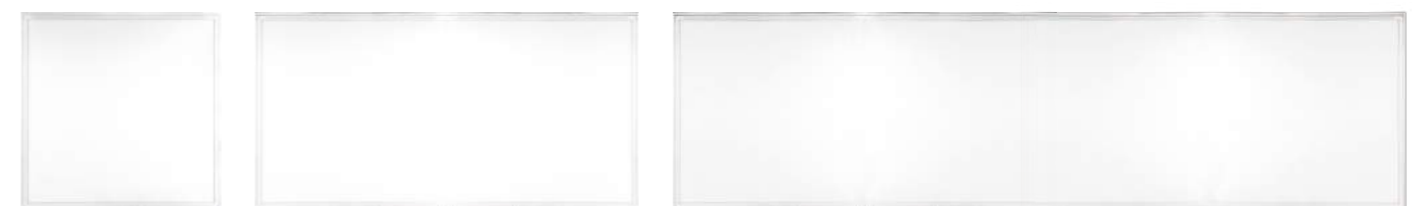

FSP26330

FSP26360

FSP26312

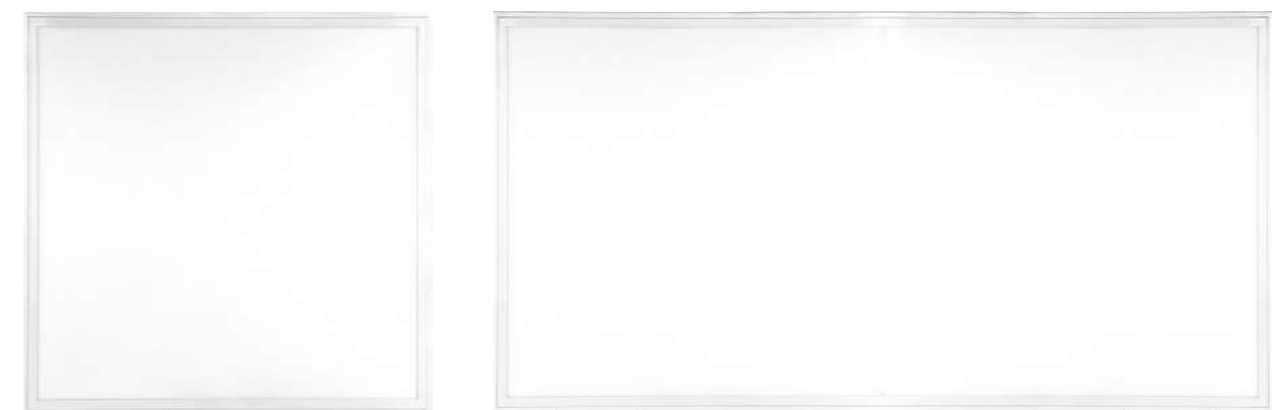

FSP26660

FSP26612

LED PANEL LAMP



| Code | Voltage | Power (W) | Lumen(lm) 3000/4000/6500K | Size (mm) | Cut-out (mm) | Packing QTY (pcs/CTN) |
|-------------------|------------|-----------|------------------------------|---------------|--------------|-----------------------|
| AC180-265V | | | | | | |
| FSP28330-12 | AC180-265V | 12 | 700/800/900 | 295x295x11.5 | 285x285 | 10 |
| FSP28360-18 | AC180-265V | 18 | 1150/1250/1350 | 295x595x11.5 | 285x585 | 10 |
| FSP28660-40 | AC180-265V | 40 | 3000/3100/3200 | 595x595x11.5 | 585x585 | 6 |
| FSP28660-48 | AC180-265V | 48 | 3600/3700/3800 | 595*595x11.5 | 585x585 | 6 |
| FSP28660-60 | AC180-265V | 60 | 4600/4700/4800 | 595x595x11.5 | 585x585 | 6 |
| FSP28312-40 | AC180-265V | 40 | 3000/3100/3200 | 295x1195x11.5 | 285x1185 | 6 |
| FSP28312-48 | AC180-265V | 48 | 3600/3700/3800 | 295x1195x11.5 | 285x1185 | 6 |
| FSP28612-80 | AC180-265V | 80 | 6200/6300/6400 | 595x1195x11.5 | 585x1185 | 2 |
| AC90-265V | | | | | | |
| FSP29330-12 | AC90-265V | 12 | 700/800/900 | 295x295x11.5 | 285x285 | 10 |
| FSP29360-18 | AC90-265V | 18 | 1150/1250/1350 | 295x595x11.5 | 285x585 | 10 |
| FSP29660-40 | AC90-265V | 40 | 3000/3100/3200 | 595x595x11.5 | 585x585 | 6 |
| FSP29660-48 | AC90-265V | 48 | 3600/3700/3800 | 595*595x11.5 | 585x585 | 6 |
| FSP29660-60 | AC90-265V | 60 | 4600/4700/4800 | 595x595x11.5 | 585x585 | 6 |
| FSP29312-40 | AC90-265V | 40 | 3000/3100/3200 | 295x1195x11.5 | 285x1185 | 6 |
| FSP29312-48 | AC90-265V | 48 | 3600/3700/3800 | 295x1195x11.5 | 285x1185 | 6 |
| FSP29612-80 | AC90-265V | 80 | 6200/6300/6400 | 595x1195x11.5 | 585x1185 | 2 |

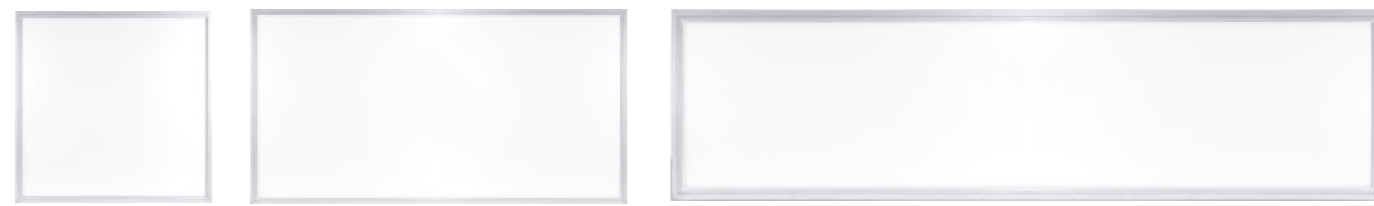
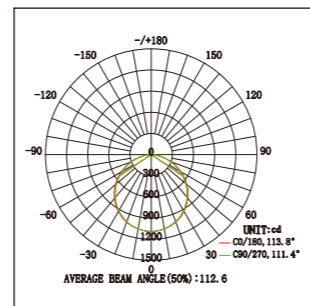
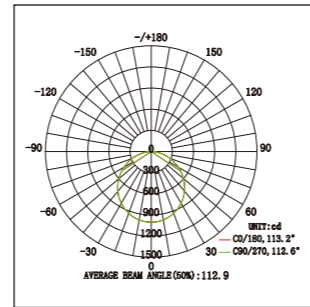

FSP29330

FSP29360

FSP29312



FSP29660

FSP29612

OPTIONAL INSTALLATION ACCESSORIES



FSP30/FSP31



FSP30/FSP31



FSP26/FSP27/FSP28/FSP29



FSP26/FSP27/FSP28/FSP29

SURFACE MOUNTED ACCESSORIES FOR PANEL LIGHT



FSP08312



FSP08660